

Varenummer: 23017741114
 Beskrivelse: E+G Håndhjul
 VR.160 FP-A14

Mål

VR.FP-A

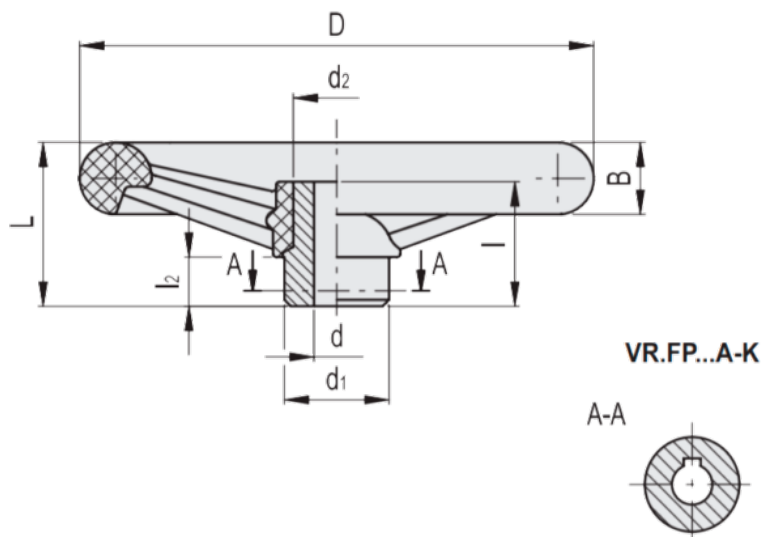

B	= 22	l	= 38
b	= 5	L	= 50
C (N*m)	= 165	L (J)	= 12
D	= 157	l2	= 15
d1	= d8	t	= 18.3
d2	= 24		
d'	= 20		
d''	= 16		